

Dual 1 Form A/B, C Solid State Relay

Features

- Current Limit Protection
- Isolation Test Voltage 3750 V_{RMS}
- Typical R_{ON} 10 Ω
- Load Voltage 200 V
- Load Current 200 mA
- High Surge Capability
- Clean Bounce Free Switching
- Low Power Consumption
- SMD Lead Available on Tape and Reel
- Lead (Pb)-free component
- Component in accordance to RoHS 2002/95/EC and WEEE 2002/96/EC

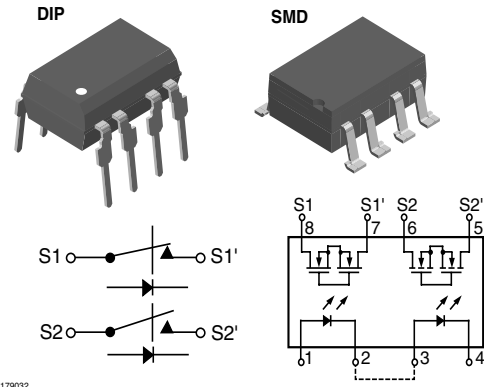

Agency Approvals

- UL1577, File No. E52744 System Code H or J, Double Protection
- CSA - Certification 093751

Applications

- General Telecom Switching
 - On/off Hook Control
 - Ring Delay
 - Dial Pulse
 - Ground Start
 - Ground Fault Protection
- Instrumentation
- Industrial Controls

Description

The LH1512 relays contain normally open and normally closed switches that can be used independently as a 1 Form A and 1 Form B relay, or when used together, as a 1 Form C relay. The relays are constructed as a mult.- chip hybrid device. Actuation control is via an Infrared LED. The output switch is a combination of a photodiode array with MOSFET switches and control circuitry.

Order Information

Part	Remarks
LH1512BAC	Tubes, SMD-8
LH1512BACTR	Tape and Reel, SMD-8
LH1512BB	Tubes, DIP-8

Absolute Maximum Ratings, T_{amb} = 25 °C

Stresses in excess of the absolute Maximum Ratings can cause permanent damage to the device. Functional operation of the device is not implied at these or any other conditions in excess of those given in the operational sections of this document. Exposure to absolute Maximum Ratings for extended periods of time can adversely affect reliability.

SSR

Parameter	Test condition	Symbol	Value	Unit
LED continuous forward current		I _F	50	mA
LED reverse voltage	I _R ≤ 10 μA	V _R	5.0	V
DC or peak AC load voltage	I _L ≤ 50 μA	V _L	200	V
Continuous DC load current (Form C operation)		I _L	200	mA
Peak load current, Form A	t = 100 ms	I _P	2)	

Parameter	Test condition	Symbol	Value	Unit
Peak load current (single shot) Form B		I_P	400	mA
Ambient operating temperature range		T_{amb}	- 40 to + 85	°C
Storage temperature range		T_{stg}	- 40 to + 125	°C
Pin soldering temperature	$t = 10 \text{ s max}$	T_{sld}	260	°C
Input/output isolation test voltage	$t = 1.0 \text{ s}, I_{ISO} = 10 \mu\text{A max}$	V_{ISO}	3750	V_{RMS}
Pole-to-pole isolation voltage (S1 to S2) ¹⁾ (dry air, dust free, at sea level)			1600	V
Output power dissipation (continuous)		P_{diss}	600	mW

¹⁾ Breakdown occurs between the output pins external to the package.

²⁾ Refer to Current Limit Performance Application Note for a discussion on relay operation during transient currents.

Electrical Characteristics, $T_{amb} = 25 \text{ °C}$

Minimum and maximum values are testing requirements. Typical values are characteristics of the device and are the result of engineering evaluations. Typical values are for information only and are not part of the testing requirements.

Input

Parameter	Test condition	Symbol	Min	Typ.	Max	Unit
LED forward current for switch turn-on (NO)	$I_L = 100 \text{ mA}, t = 10 \text{ ms}$	I_{Fon}		0.6	2.0	mA
LED forward current for switch turn-off (NO)	$V_L = \pm 150 \text{ V}$	I_{Foff}	0.2	0.5		mA
LED forward current for switch turn-on (NC)	$I_L = 100 \text{ mA}, t = 10 \text{ ms}$	I_{Fon}	0.2	0.9		mA
LED forward current for switch turn-off (NC)	$V_L = \pm 150 \text{ V}$	I_{Foff}		1.0	2.0	mA
LED forward voltage	$I_F = 10 \text{ mA}$	V_F	1.15	1.26	1.45	V

Output

Parameter	Test condition	Symbol	Min	Typ.	Max	Unit
ON-resistance: (NO, NC)	$I_F = 5.0 \text{ mA (NO)}, I_F = 0 \text{ mA (NC)}, I_L = 50 \text{ mA (NC)}$	R_{ON}		10	15	Ω
OFF-resistance: (NO)	$I_F = 0 \text{ mA}, V_L = \pm 100 \text{ V}$	R_{OFF}	0.35	5000		$G\Omega$
OFF-resistance: (NC)	$I_F = 5.0 \text{ mA}, V_L = \pm 100 \text{ V}$	R_{OFF}	0.1	1.4		$G\Omega$
Current limit: (NO)	$I_F = 5.0 \text{ mA}, t = 5.0 \text{ ms}, V_L = \pm 5.0 \text{ V}$	I_{LMT}	270	360	460	mA
Off-state leakage current: (NO)	$I_F = 0 \text{ mA}, V_L = \pm 100 \text{ V}$	I_O		0.02	1000	nA
Off-state leakage current: (NC)	$I_F = 5.0 \text{ mA}, V_L = \pm 100 \text{ V}$	I_O		0.07	1.0	μA
Off-state leakage current: (NO, NC)	$I_F = 0 \text{ mA (NO)}, I_F = 5.0 \text{ mA}, V_L = \pm 200 \text{ V}$	I_O			1.0	μA
Output capacitance: (NO)	$I_F = 0 \text{ mA}, V_L = 50 \text{ V}$	C_O		60		pF
Output capacitance: (NC)	$I_F = 5.0 \text{ mA}, V_L = 50 \text{ V}$	C_O		60		pF

Transfer

Parameter	Test condition	Symbol	Min	Typ.	Max	Unit
Capacitance (input-output)	$V_{ISO} = 1.0\text{ V}$	C_{IO}		3.0		pF
Turn-on time (NO)	$I_F = 10\text{ mA}, I_L = 50\text{ mA}$	t_{on}		1.4	3.0	ms
Turn-on time (NC)	$I_F = 10\text{ mA}, I_L = 50\text{ mA}$	t_{on}		1.2	3.0	ms
Turn-off time (NO)	$I_F = 10\text{ mA}, I_L = 50\text{ mA}$	t_{off}		0.7	3.0	ms
Turn-off time (NC)	$I_F = 10\text{ mA}, I_L = 50\text{ mA}$	t_{off}		2.0	3.0	ms

Typical Characteristics (Tamb = 25 °C unless otherwise specified)

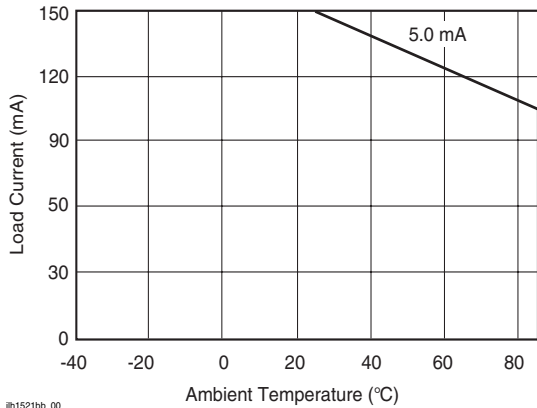

ih1512bb_00

Figure 1. Recommended Operating Conditions

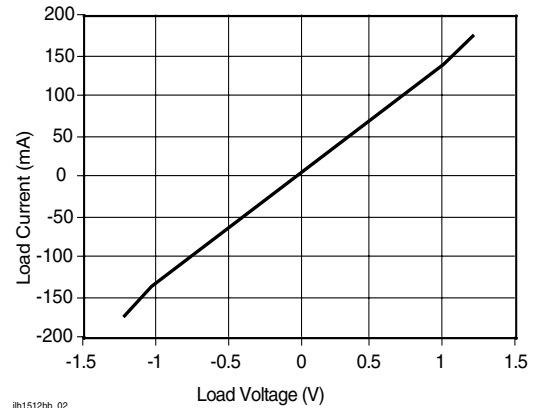

ih1512bb_02

Figure 3. Form A_Typical Load Current vs. Load Voltage

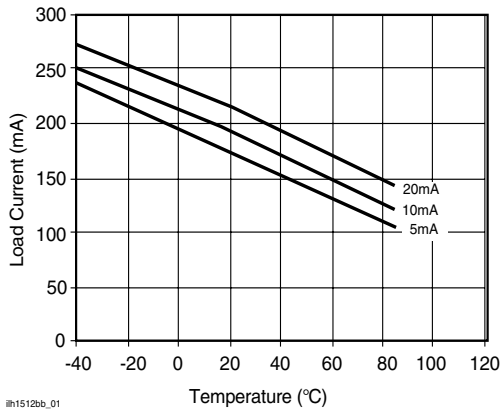

ih1512bb_01

Figure 2. Form A_Typical Load Current vs. Temperature

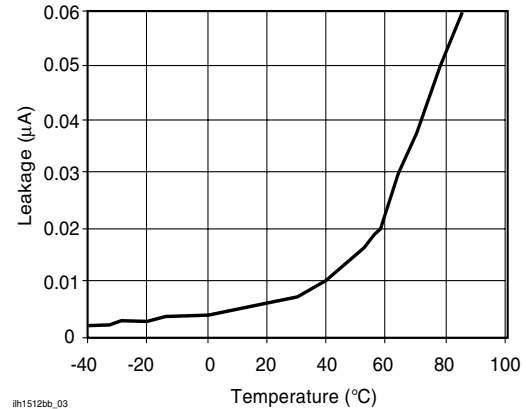

ih1512bb_03

Figure 4. Typical Leakage vs. Temperature (Measured across Pin 5&6 or 7&8)

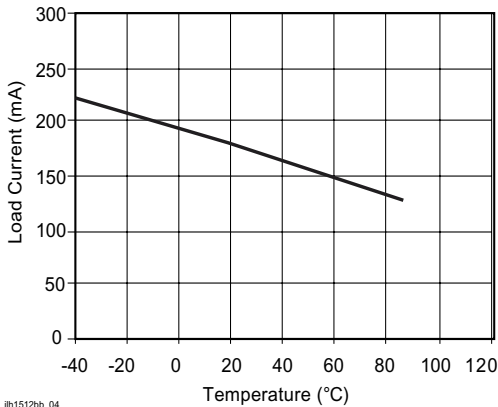

Figure 5. Form B_Typical Load Current vs. Temperature

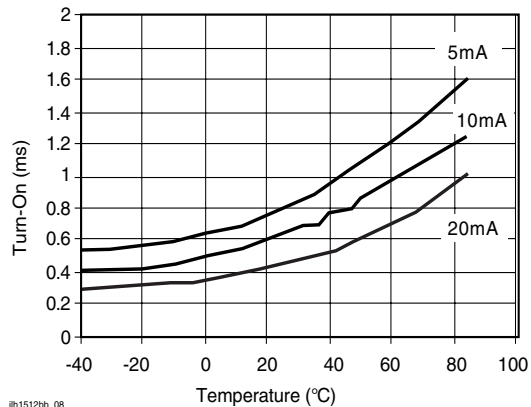

Figure 8. Form A_Typical Turn-On vs. Temperature

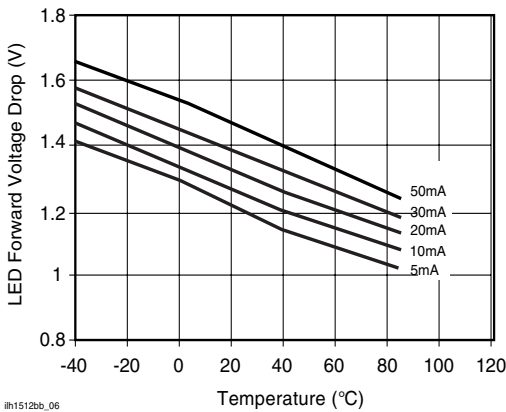

Figure 6. Typical LED Forward Voltage Drop vs. Temperature

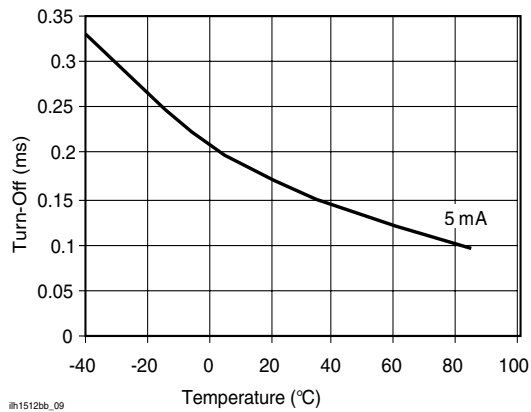

Figure 9. Form A_Typical Turn-Off vs. Temperature

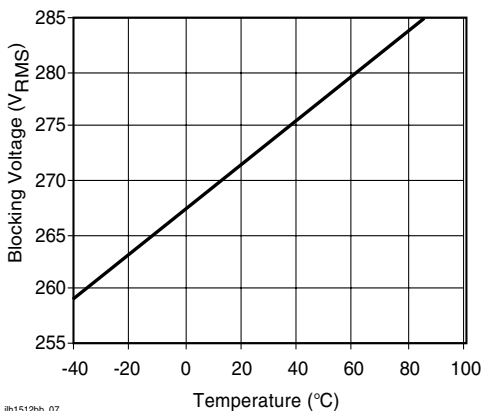

Figure 7. Form A_Typical Blocking Voltage vs. Temperature

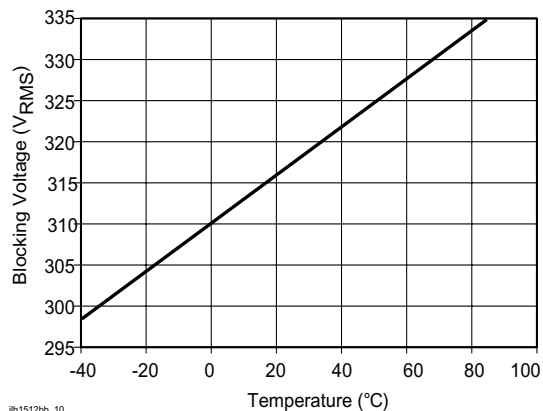
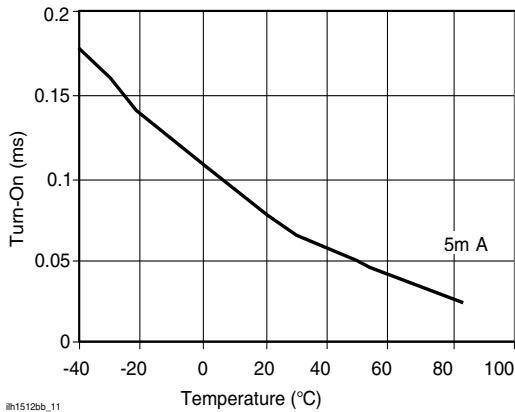
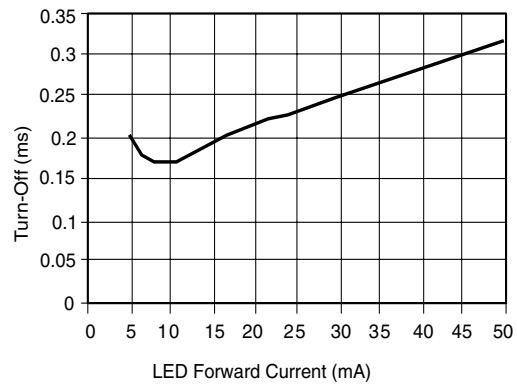

Figure 10. Form B_Typical Blocking Voltage vs. Temperature



ih1512bb_11

Figure 11. Form B_Typical Turn-On vs. Temperature



ih1512bb_14

Figure 14. Form A_Typical Turn-Off vs. LED Forward Current

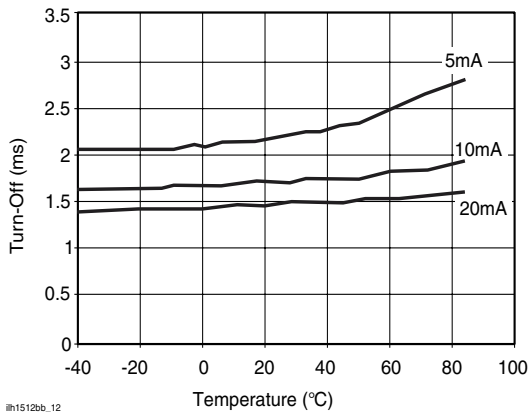

ih1512bb_12

Figure 12. Form B_Typical Turn-Off vs. Temperature

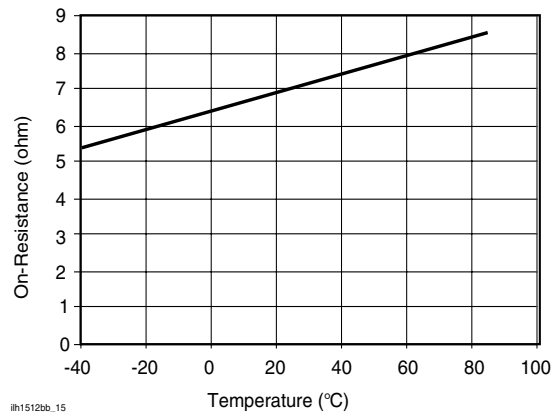

ih1512bb_15

Figure 15. Form A_Typical On-Resistance vs. Temperature

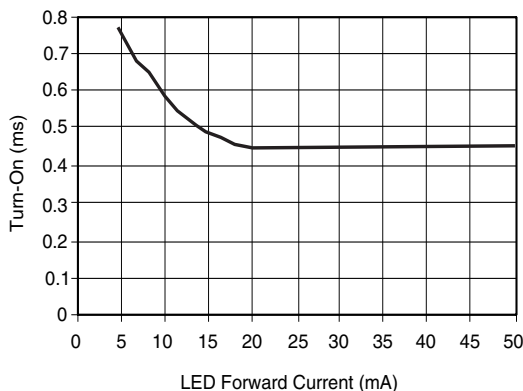

ih1512bb_13

Figure 13. Form A_Typical Turn-On vs. LED Forward Current

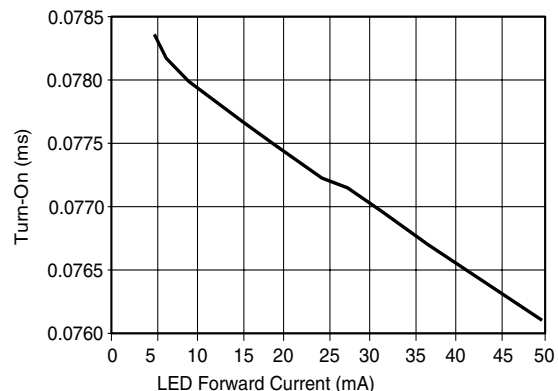

ih1512bb_16

Figure 16. Form B_Typical Turn-On vs. LED Forward Current

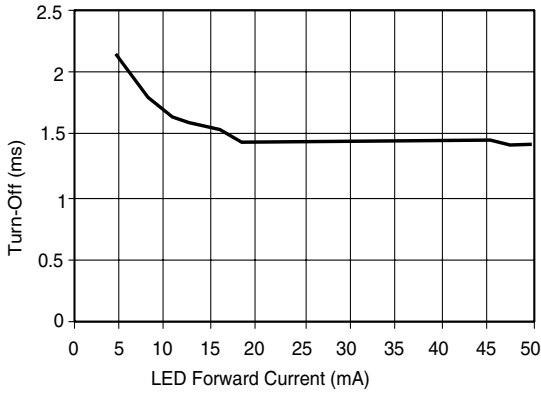

ih1512bb_17

Figure 17. Form B_Typical Turn-Off vs. LED Forward Current

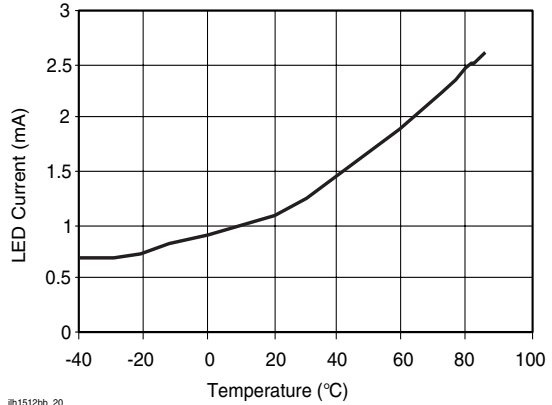

ih1512bb_20

Figure 20. Form A_Typical I_F for Switch Dropout vs. Temperature

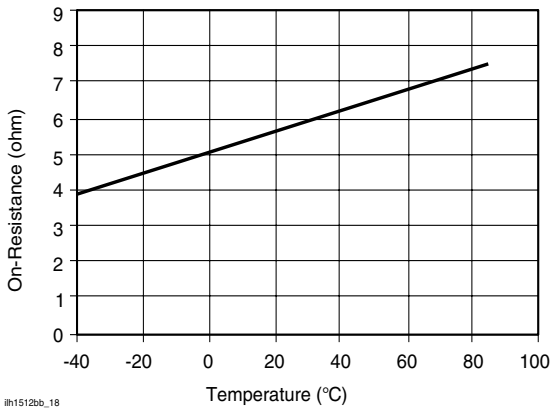

ih1512bb_18

Figure 18. Form B_Typical On-Resistance vs. Temperature

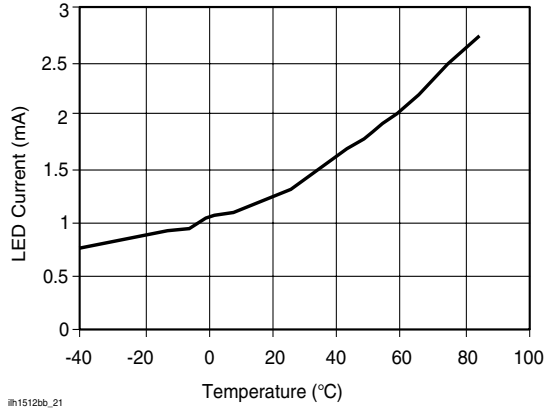

ih1512bb_21

Figure 21. Form B_Typical I_F for Switch Operation vs. Temperature

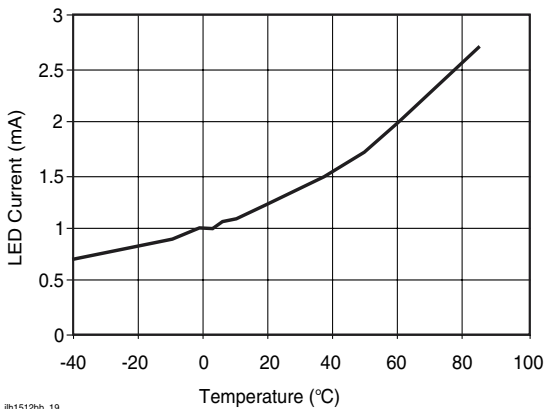

ih1512bb_19

Figure 19. Form A_Typical I_F for Switch Operation vs. Temperature

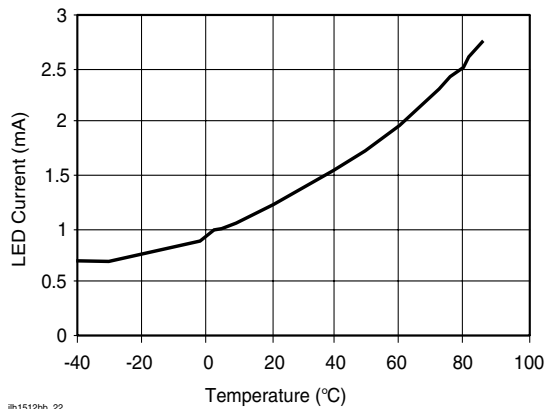

ih1512bb_22

Figure 22. Form B_Typical I_F for Switch Dropout vs. Temperature

Package Dimensions in Inches (mm)

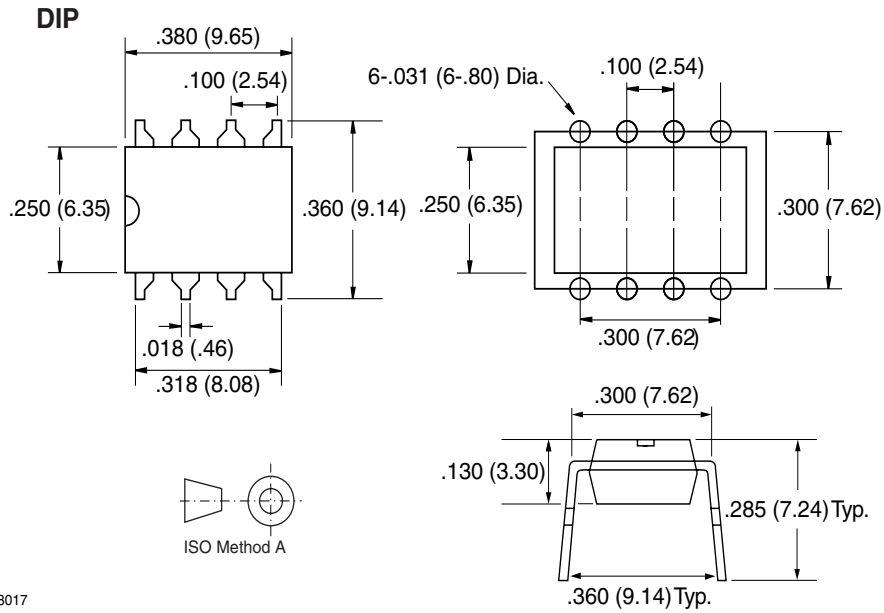

Package Dimensions in Inches (mm)

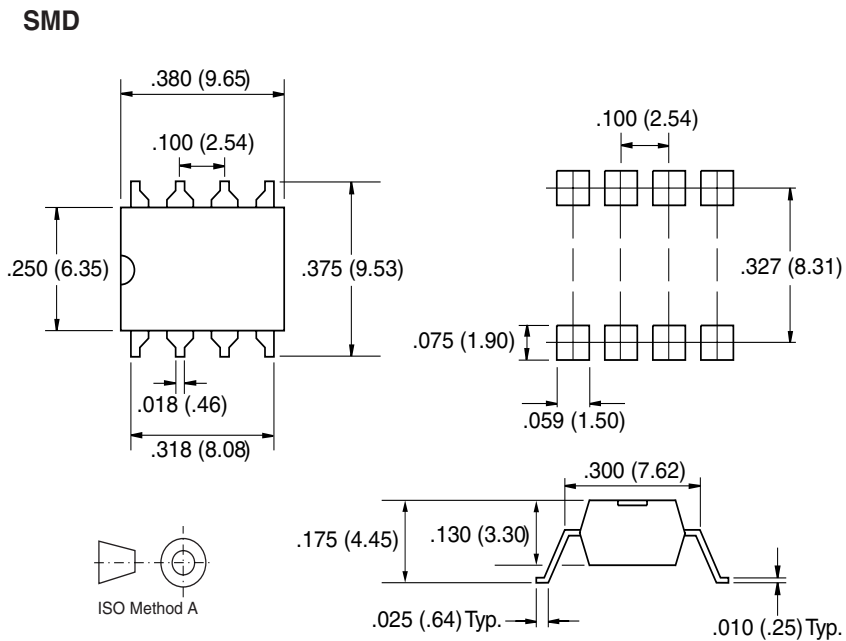

Ozone Depleting Substances Policy Statement

It is the policy of Vishay Semiconductor GmbH to

1. Meet all present and future national and international statutory requirements.
2. Regularly and continuously improve the performance of our products, processes, distribution and operating systems with respect to their impact on the health and safety of our employees and the public, as well as their impact on the environment.

It is particular concern to control or eliminate releases of those substances into the atmosphere which are known as ozone depleting substances (ODSs).

The Montreal Protocol (1987) and its London Amendments (1990) intend to severely restrict the use of ODSs and forbid their use within the next ten years. Various national and international initiatives are pressing for an earlier ban on these substances.

Vishay Semiconductor GmbH has been able to use its policy of continuous improvements to eliminate the use of ODSs listed in the following documents.

1. Annex A, B and list of transitional substances of the Montreal Protocol and the London Amendments respectively
2. Class I and II ozone depleting substances in the Clean Air Act Amendments of 1990 by the Environmental Protection Agency (EPA) in the USA
3. Council Decision 88/540/EEC and 91/690/EEC Annex A, B and C (transitional substances) respectively.

Vishay Semiconductor GmbH can certify that our semiconductors are not manufactured with ozone depleting substances and do not contain such substances.

We reserve the right to make changes to improve technical design
and may do so without further notice.

Parameters can vary in different applications. All operating parameters must be validated for each customer application by the customer. Should the buyer use Vishay Semiconductors products for any unintended or unauthorized application, the buyer shall indemnify Vishay Semiconductors against all claims, costs, damages, and expenses, arising out of, directly or indirectly, any claim of personal damage, injury or death associated with such unintended or unauthorized use.

Vishay Semiconductor GmbH, P.O.B. 3535, D-74025 Heilbronn, Germany



Disclaimer

All product specifications and data are subject to change without notice.

Vishay Intertechnology, Inc., its affiliates, agents, and employees, and all persons acting on its or their behalf (collectively, "Vishay"), disclaim any and all liability for any errors, inaccuracies or incompleteness contained herein or in any other disclosure relating to any product.

Vishay disclaims any and all liability arising out of the use or application of any product described herein or of any information provided herein to the maximum extent permitted by law. The product specifications do not expand or otherwise modify Vishay's terms and conditions of purchase, including but not limited to the warranty expressed therein, which apply to these products.

No license, express or implied, by estoppel or otherwise, to any intellectual property rights is granted by this document or by any conduct of Vishay.

The products shown herein are not designed for use in medical, life-saving, or life-sustaining applications unless otherwise expressly indicated. Customers using or selling Vishay products not expressly indicated for use in such applications do so entirely at their own risk and agree to fully indemnify Vishay for any damages arising or resulting from such use or sale. Please contact authorized Vishay personnel to obtain written terms and conditions regarding products designed for such applications.

Product names and markings noted herein may be trademarks of their respective owners.